

01-15-XX
01-63-XX
01-15-XXM
01-64-XX

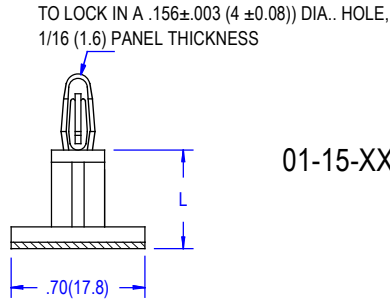
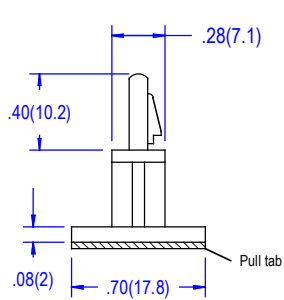

01-15-XX

ITEM NO.	L ± .015 (0.38)	
	In.	mm
01-15-30	.187	4.8
01-15-40	.250	6.35
01-15-60	.375	9.6
01-15-80	.500	12.7
01-15-100	.625	15.9
01-15-120	.750	19.1
01-15-140	.875	22.3
01-15-160	1.00	25.4
01-15-180	1.125	28.6

PACKAGING: 1000 PCS PER BAG

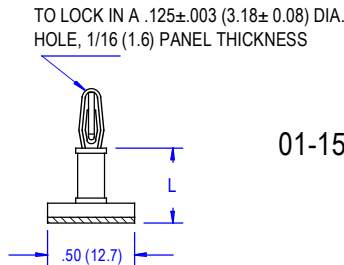
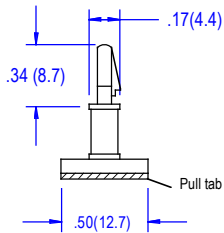

01-15-XXM

ITEM NO.	L ± .015 (0.38)	
	In.	mm
01-15-30M	.187	4.8
01-15-40M	.250	6.35
01-15-50M	.312	7.9
01-15-60M	.375	9.6
01-15-70M	.437	11.1
01-15-80M	.500	12.7
01-15-90M	.563	14.3
01-15-100M	.625	15.9

PACKAGING: 1000 PCS PER BAG

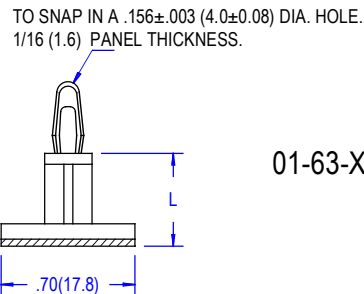
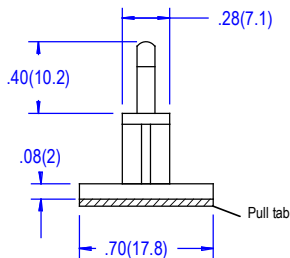

01-63-XX

ITEM NO.	L ± .015 (0.38)	
	In.	mm
01-63-30	.187	4.8
01-63-40	.250	6.35
01-63-60	.375	9.6
01-63-80	.500	12.7
01-63-100	.625	15.9
01-63-120	.750	19.1
01-63-140	.875	22.3
01-63-160	1.0	25.4
01-63-180	1.125	28.6

PACKAGING: 500PCS PER BAG

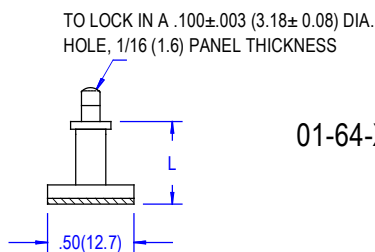
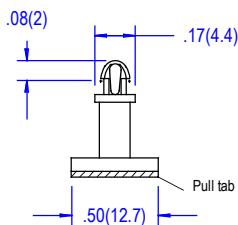

01-64-XX

ITEM NO.	L ± .015 (0.38)	
	In.	mm
01-64-30	.187	4.8
01-64-40	.250	6.35
01-64-50	.312	7.9
01-64-60	.375	9.6
01-64-70	.437	11.1
01-64-80	.500	12.7
01-64-90	.563	14.3
01-64-100	.625	15.9

PACKAGING: 1000PCS PER BAG

ADHESIVE
CARRIER
THICKNESS
COLOR
UL FILE NO.
RoHS COMPLIANCE
SERVICE TEMPERATURE
MR NUMBER

RUBBER
POLYETHYLENE FOAM
.040 (1mm)
WHITE
NA
YES
14 to 113°F (-10 to 45°C)
59

MATERIAL
UL RATING
UL FILE NO.
COLOR
RoHS COMPLIANCE
SERVICE TEMPERATURE (REF.)
MR NUMBER

NYLON 66
94V-2
E41938
NATURAL
YES
-40 to 185°F (-40 to 85°C)
12

Note: Acrylic adhesive available on request .

Note: Nylon 66 rated UL94V-0 available on request.
To order add suffix "X" to Item number.

C	Changed tape to MR-59	9-17-20	FL	ALL ELECTRONICS HARDWARE , INC. 2642 CORPORATE PARKWAY ALGONQUIN, IL. 60102 1-800-778-7234	Title	Issue
A	modified spacer of series 01-15-XXM	10-14-11	FL		PCB SUPPORT ON BASE	C
No	Revision	Date	By	File No.	011515M6364	09-17-20